

PSP-20A.DC-UL Power Supply Panel



Functional Fenestration Inc (FFI) is an expert and leader in the American motorized actuator market, with a broad range of motors for windows, vents, and skylights. FFI has been providing motorized operators for natural ventilation since 1987, for residential and commercial applications.

- (1) DIN rail mounted 20 amp power supply in a pre-assembled panel
- (1) Ground terminal strip
- (1) DC output mounting strip

Applications

This Power Supply Panel accepts 120-244VAC line voltage input and provides 480W at 24VDC. Contains one high efficiency, 94% and low power dissipation power supply and other components as needed for a complete installation-ready power solution.

Features & Benefits

- **Steel box enclosure** is UL certified, self-contained and ready to install. Has removable screw-cover, knockouts on all 4 sides and ventilation port. Dimensions 12 in x 12 in x 6 in.
- **Contains one power supply**, 20A, 480W, high efficiency with 150% peak load capability and protection for short circuit, overload, over voltage and over temperature. Power supply comes mounted to enclosure box DIN rail.
- **DIN rail mounted fuse/holder.**
- **DC Output strips** for connecting multiple DC actuators.
- **3 year warranty.**
- **Decrease installation costs** by using power supply panels.
- **Accessories** sold separately as needed per project.
- **Use with Momentary Contact SPDT Switch**, FFI part #SW5657-2W (or other dry contact switch).



PSP-20A.DC-UL Power Supply Panel

20 amp power supply, UL listed

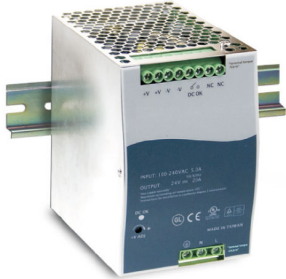

- Supply voltage 24 V DC
- Rated current 20 amp
- Rated power 480W
- Peak power 720W (3 seconds maximum)
- Cooling Free air convection
- Protections Short circuit / Overload / Over voltage / Over temperature
- Working temperature -25 to +70 ° C.

Supply voltage	24 VDC
Rated current	20 amp
Rated power	480W
Peak power	720W (3 seconds maximum)
Cooling	Free air convection
Protections	Short circuit / Overload / Over voltage / Over temperature
Working temperature	-25 to +70° C

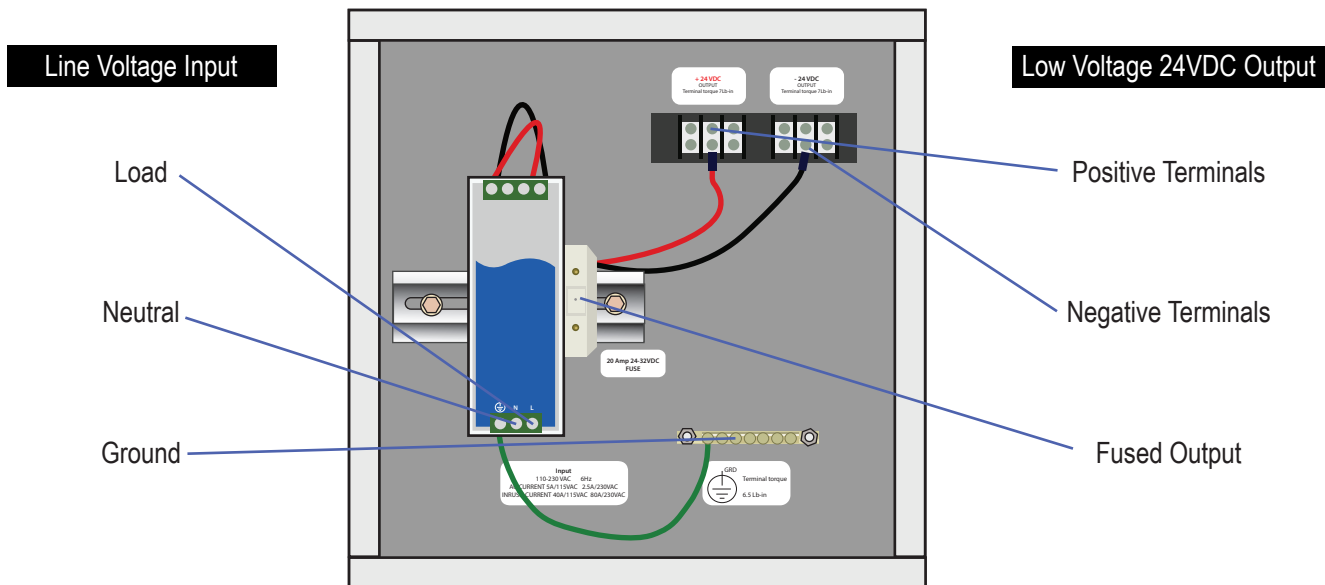

Warning: Do not add components or disconnect internal wires or components in FFI Panels or warranty is void!
Only connect automation lead wires and power input according to FFI Installation Guide.

Recommendations for FFI Actuators & Controls: FFI only recommends UL compliant systems. FFI is a UL registered firm. Read FFI data sheets & installation guides before specifying project details. Project-specific needs vary depending on the number of actuators, electrical layouts, building management systems, distance between power supplies & actuators, and other details. Project specifications to comply with electric & building codes—for wire gauge, wire connections and run distance, conduits, junction boxes—must be arranged by the project electrical contractors. Distribute this guide to all project parties, including electrical contractors, architects, and building management personnel.